

Welle A-Seite
shaft DE

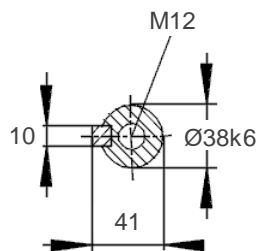

optional
Welle B-Seite

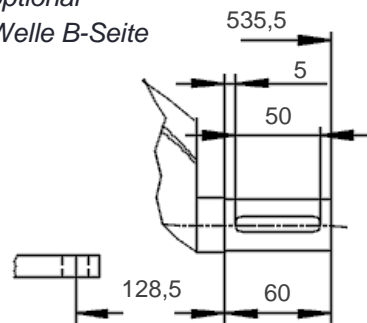

optional
shaft NDE

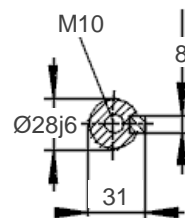

optional
Schutzdach

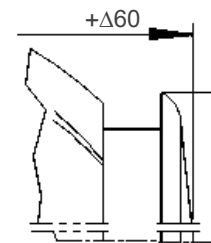

optional
canopy

Änderungen und Irrtümer vorbehalten / Subject to change without prior notice!

Datum / Date 29.09.2020

Version 2.00.086



1TZ9011-1CR2 - B3